

Data Sheet



Article number: 339706510000

Description: Multibeam 6 Coupling 706.51.0000
Aluminium relieved & set screw hubs

Measures

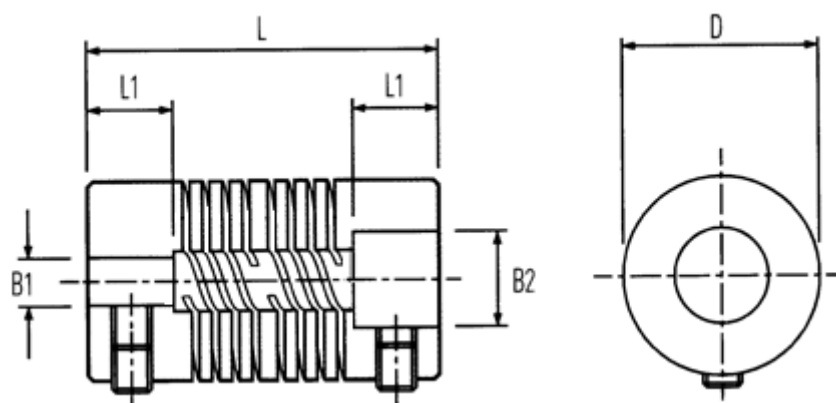

B1: Pre-drilled	= 10.0
B2: Pre-drilled	= 16.00
D	= 50.8
L	= 95.3
L1	= 25.0
Max angular displacement	= 0.90
Max B1 & B2	= 28.00
Max parallel displacement	= 7

Peak Torque NM	= 40.00
Set Screw	= M8